

PROGRAMMA MISCELAZIONE BAGNO
BATH MIXING PROGRAM
PROGRAMME DU MITIGEUR POUR LA SALLE DE BAIN
BAD-MISCHUNGSPROGRAMM
PROGRAMA MEZCLADORES BAÑO
ПРОГРАММА СМЕСИТЕЛЕЙ ДЛЯ ВАННОЙ
ΛΟΥΤΡΟ ΠΟΥ ΑΝΑΜΙΓΝΥΕΙ ΤΟ ΠΡΟΓΡΑΜΜΑ
浴室混水产品

ELEGANZA

Art. 46142

Art. 46144

Art. 46145

GESSI 

Gessi SpA - Parco Gessi

13037 Serravalle Sesia (Vercelli) - Italy

Phone +39 0163 454111 - Facsimile +39 0163 459273

www.gessi.com - gessi@gessi.it

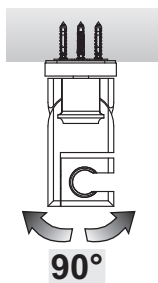
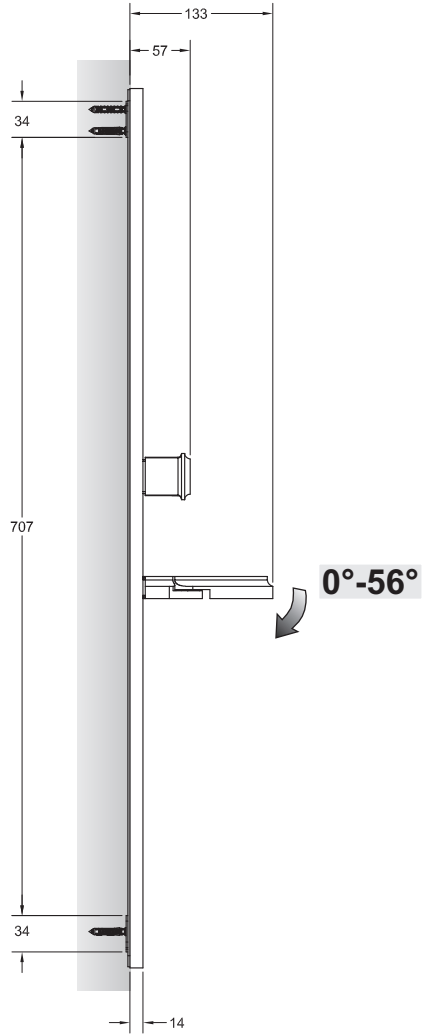
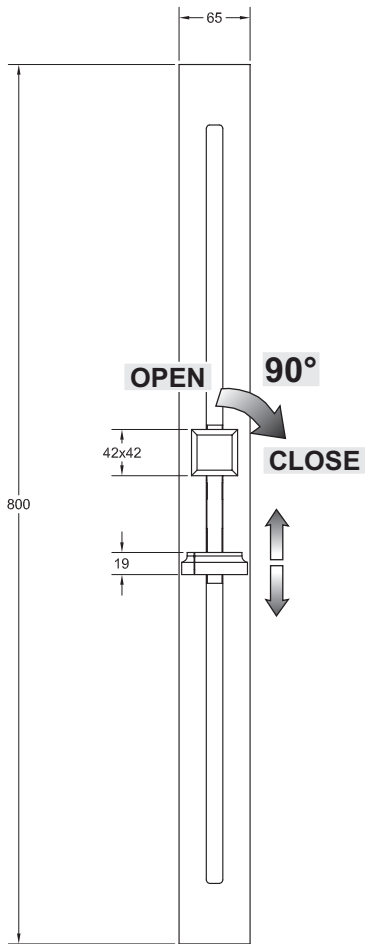

Prima dell'installazione e messa in funzione

Attenzione! I tubi d'alimentazione devono essere sciacquati con cura prima dell'installazione del dispositivo, in modo che non rimangano trucioli, residui di saldatura o canapa, o altre impurità all'interno dei tubi. Attraverso tubazioni non sciacquate a fondo o attraverso la rete idrica generale, nel dispositivo possono entrare corpi estranei in grado di danneggiare guarnizioni/o-ring. Si raccomanda pertanto di dotare anche l'impianto generale di filtri.

Before installation and setting to work

Attention! The feeding pipes have to be rinsed carefully before the installation of the device so that there won't remain shavings, sealing or hemp residues, or other impurities inside the pipes. Through pipes not thoroughly rinsed or through the general water network, in the device foreign bodies can enter that could damage gaskets /o-ring. So filters should be installed also on the general system.

Avant l'installation et la mise en fonction

Attention! Les tuyaux d'alimentation doivent être rincés avec soin avant l'installation du dispositif, de sorte que ils ne restent pas de copeaux, des restes de soudage ou de chanvre, ou d'autres impuretés à l'intérieur des tuyaux. A travers les conduites non rincées à fond ou à travers le réseau hydrique général, dans le dispositif peuvent entrer des corps étrangers à même de détériorer les gaines/o-ring. On recommande ainsi d'installer des filtres également sur le système général.

Vor der Installation und Inbetriebnahme

Achtung! Bevor die Vorrichtung zu installieren, bitte spülen Sie die Zuleitungsröhre sorgfältig aus, um alle Spannen, Schweiß- und Hanfrückstände bzw. alle Verunreinigungen vom Inneren der Röhre zu entfernen. Durch nicht sorgfältig gespülte Rohrleitungen bzw. durch das allgemeine Wassernetz können Fremdkörper in den Korpen eintreten, die die Dichtungen bzw. die O-Ringe beschädigen können. Es ist dann empfehlenswert, die allgemeine Anlage mit Filtern auszustatten.

Antes de la instalación y la puesta en función

¡Cuidado! Los tubos de alimentación tienen que ser enjuagados escrupulosamente antes de instalar el dispositivo de manera que no haya virutas, residuos de soldadura o cáñamo u otras impurezas al interior de los tubos. A través de los tubos no perfectamente enjuagados o de la red hídrica general pueden entrar en el dispositivo unos cuerpos extraños que pueden dañar guarniciones/o-rings. Les recomendamos por lo tanto que instalen los filtros en la planta general también.

Перед установкой и началом использования

Внимание! Перед установкой смесителя необходимо тщательно промыть водопроводные трубы, чтобы в них не оставались стружка, шлак от сварки, лен или другие посторонние тела. Через плохо промытые водопроводные трубы или через общую водопроводную сеть в смеситель могут попасть посторонние тела, способные повредить уплотнения и уплотнительные кольца. Поэтому, рекомендуется оснастить фильтрами также и общую систему.

Πριν από την εγκατάσταση και έναρξη της λειτουργίας

Προσοχή! Οι σωλήνες τροφοδοσίας πρέπει να ξεπλένονται προσεκτικά πριν από την εγκατάσταση της μπαταρίας προκειμένου να αποφευχθεί η παρουσία ψηγμάτων, υπολειμμάτων συγκολλητικής ουσίας ή σπουπιού, ή άλλων ακαθαρσιών μέσα στους σωλήνες. Μέσα από όχι τέλεια καθαρισμένους σωλήνες ή μέσα από το γενικό δίκτυο παροχής νερού, στην μπαταρία μπορεί να εισχωρήσουν ξένα σώματα τα οποία μπορούν να προκαλέσουν ζημιά στα παρεμβύσματα / στους δακτύλιους κυκλικής διατομής. Έτσι λοιπόν θα πρέπει να τοποθετηθούν φίλτρα στο γενικό σύστημα.

在安装和使用前

小心! 安装本设备之前需要仔细清洗水管, 确保管道里面不存留金属屑、焊接后的残渣或麻丝, 或者是其他脏物。异质也能通过未深度冲洗的水管或更广义的水网管道进入装置, 从而损坏垫圈/O形密封圈。为此建议为总水管网配置过滤器。

CASO 1 - CASE 1

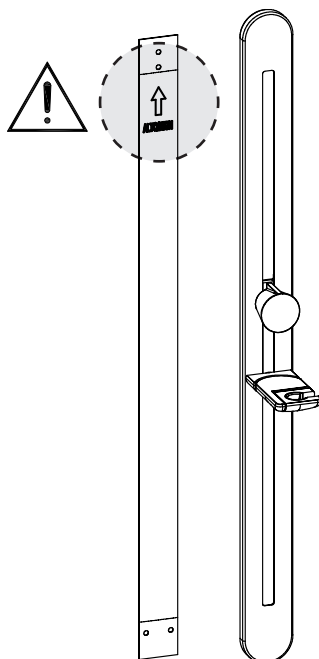

CASO 2 - CASE 2

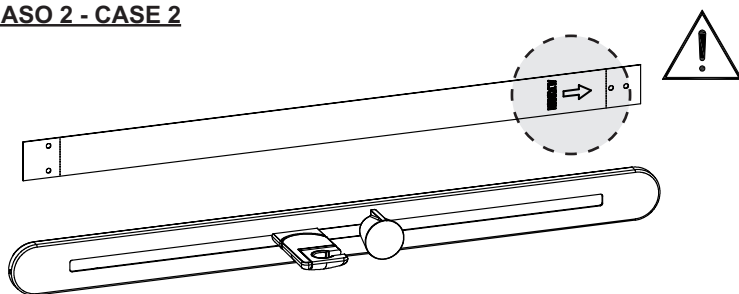

CASO 3 - CASE 3

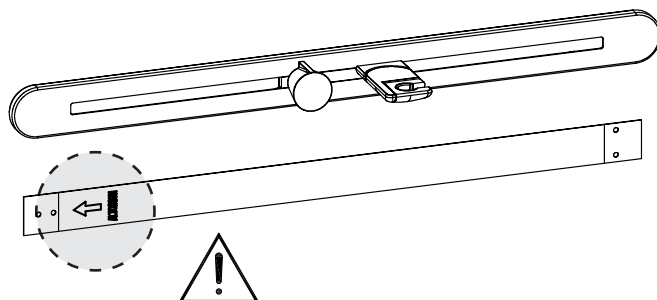

Fig. 1

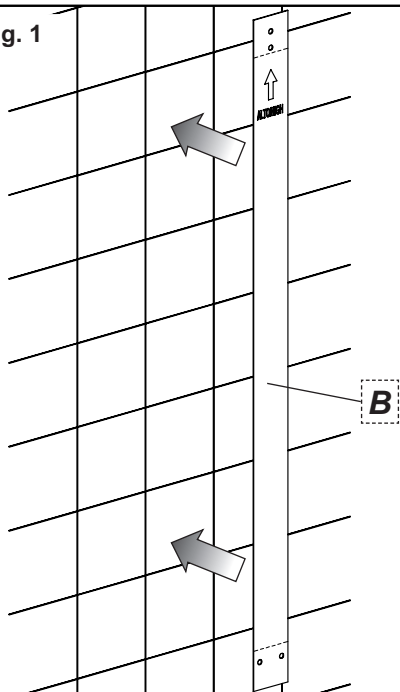

Fig. 2

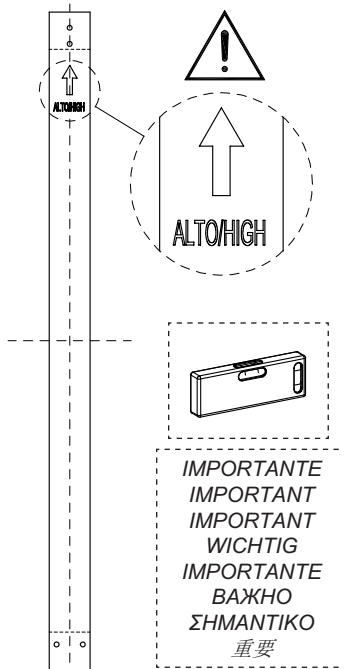

Fig. 3

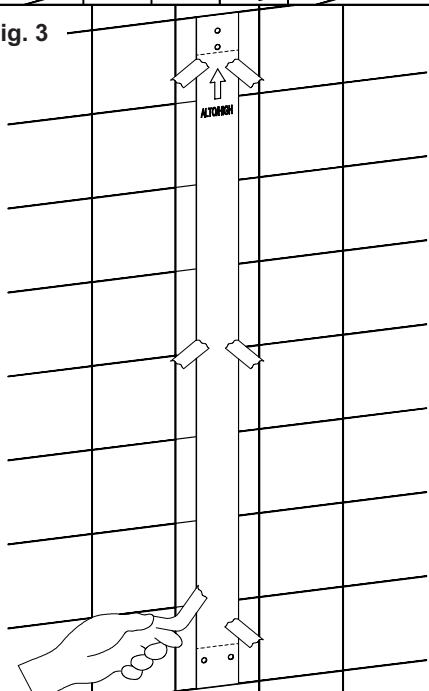

Fig. 4

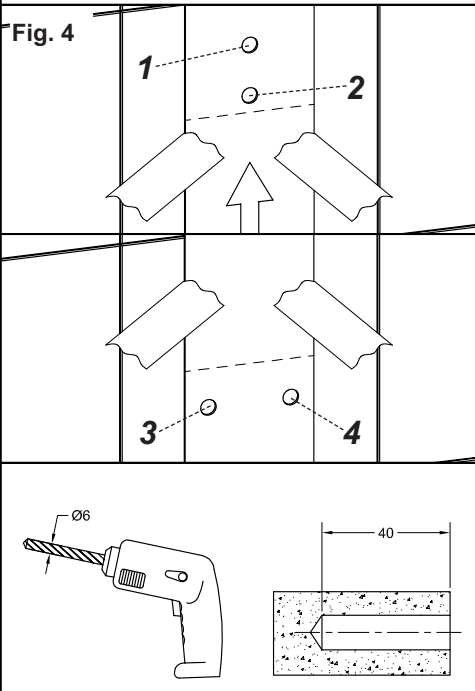

Fig. 5

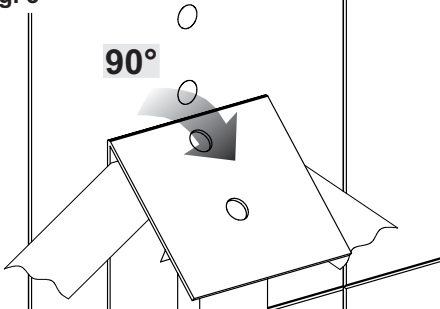

Fig. 7

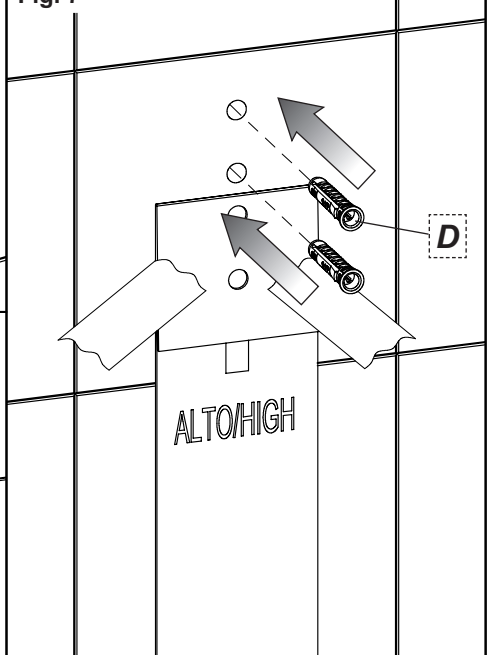

Fig. 6

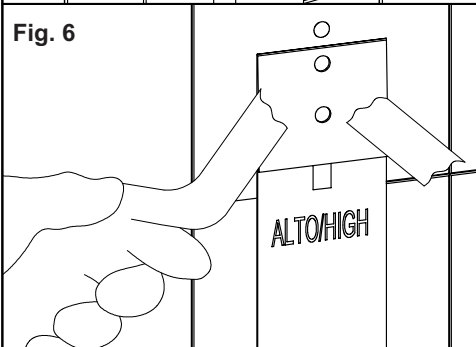

Fig. 8

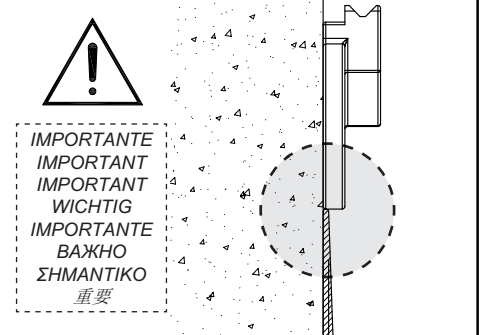
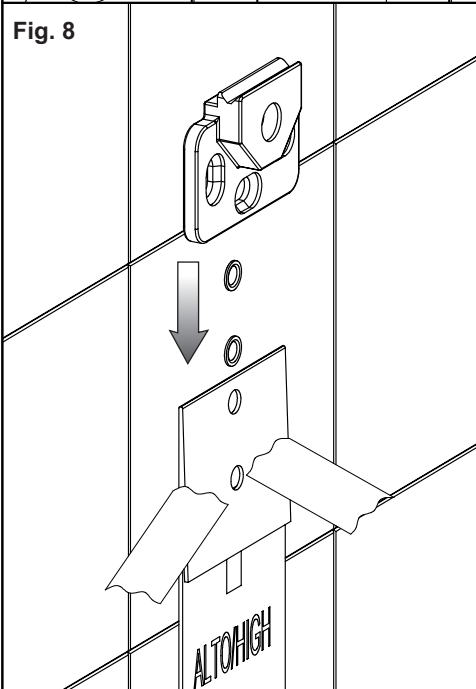

Fig. 9

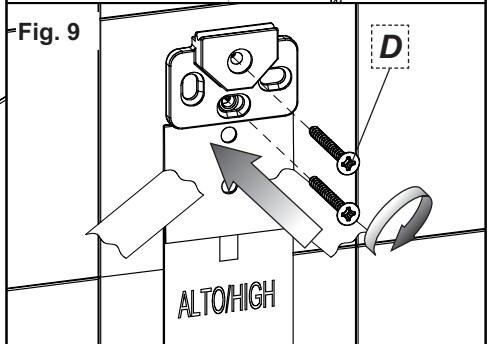

Fig. 10

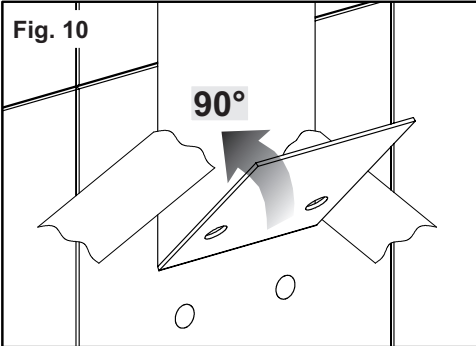

Fig. 12

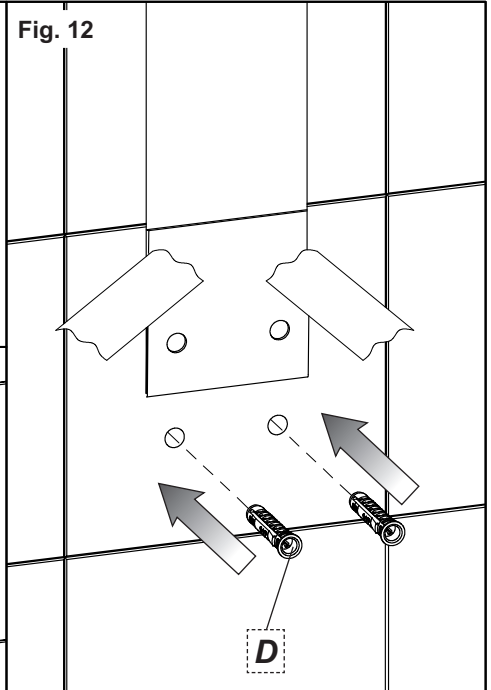

Fig. 11

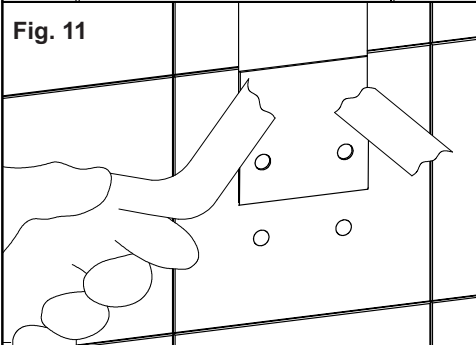

Fig. 13

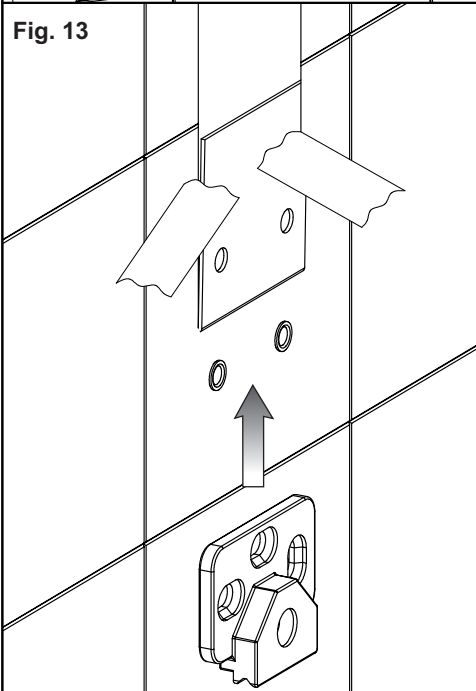

Fig. 14

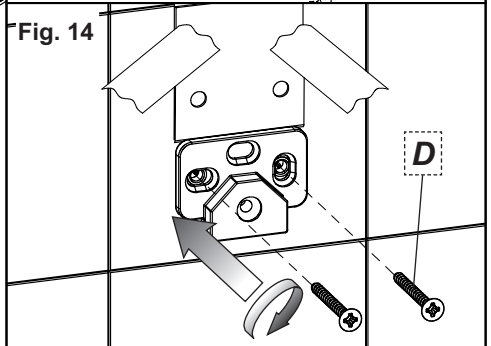

Fig. 15

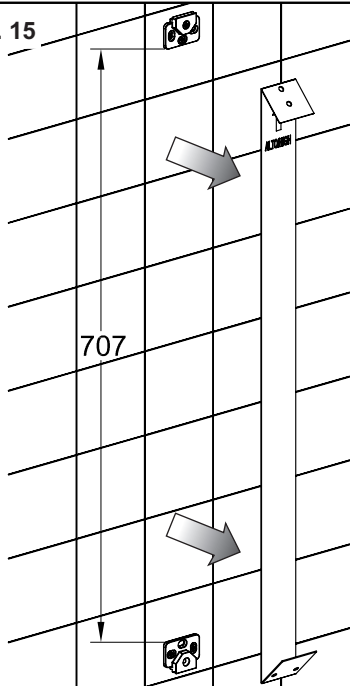

Fig. 16

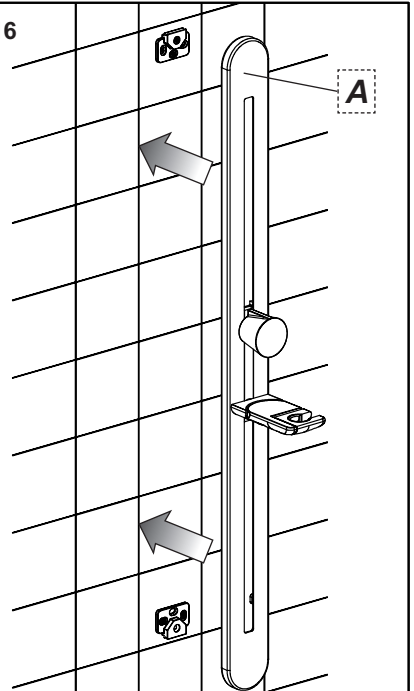
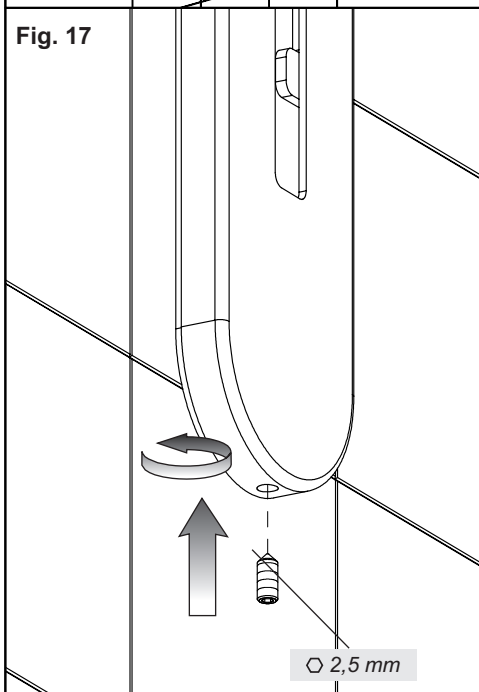

Fig. 17





CASO 2 - CASE 2
CASO 3 - CASE 3

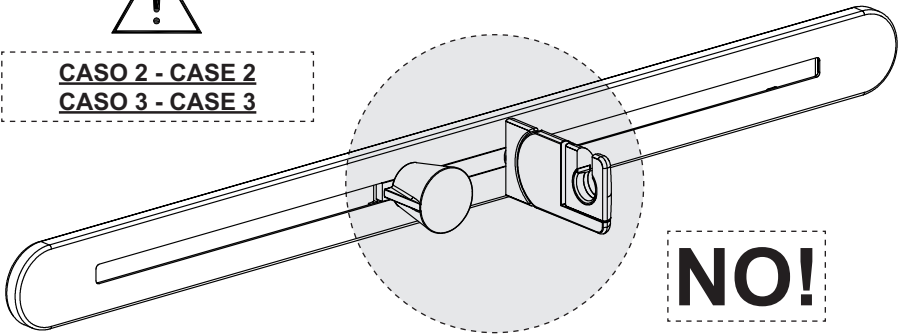

Fig. A

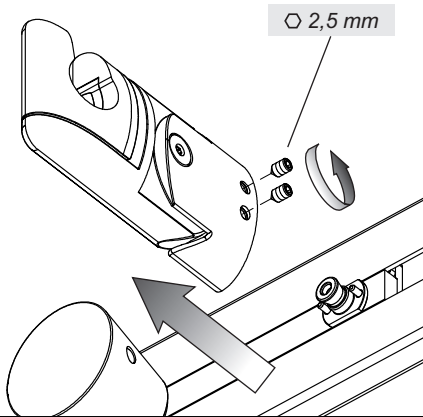

Fig. B

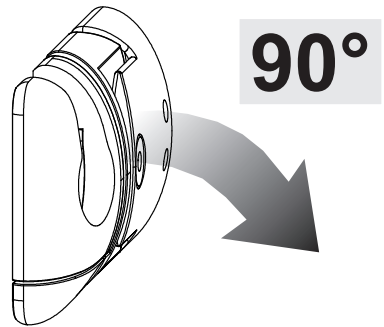

Fig. C

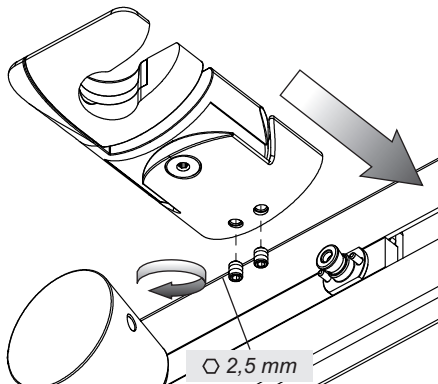

Fig. D

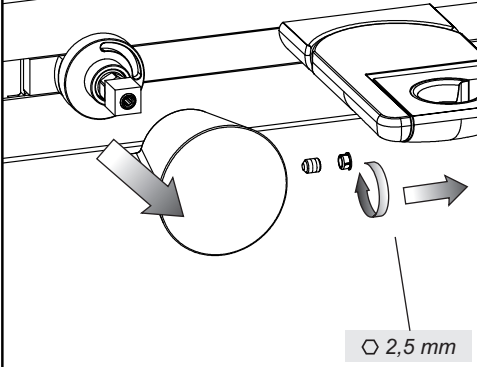

Fig. E

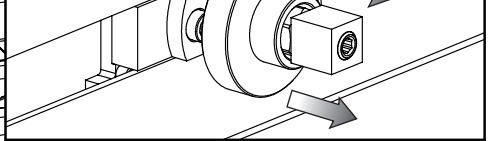

Fig. F

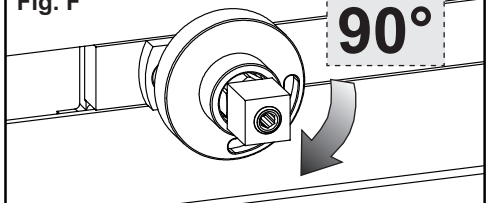

Fig. G

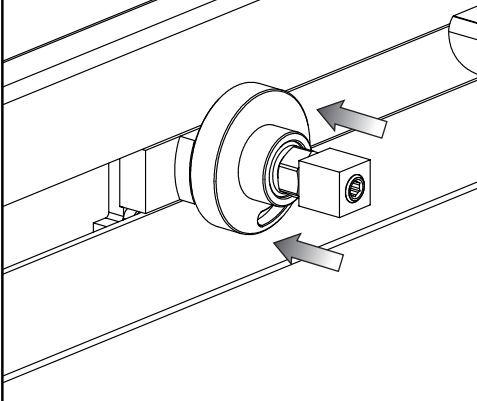
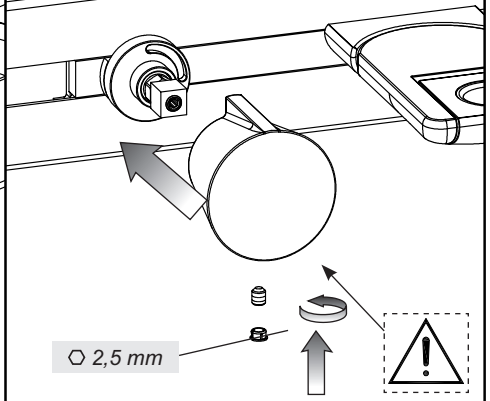

Fig. H



OK!

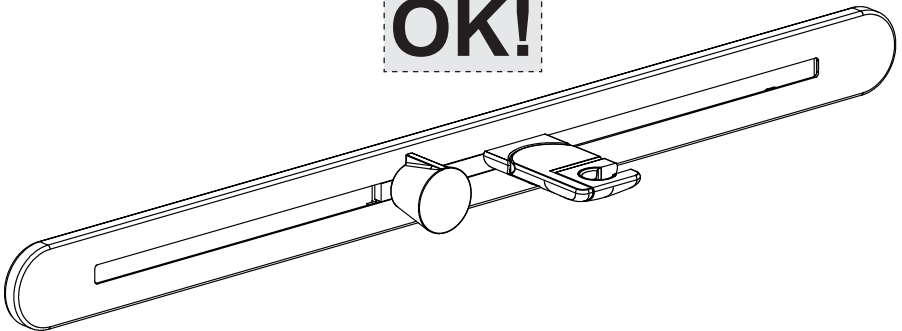

Fig. 18

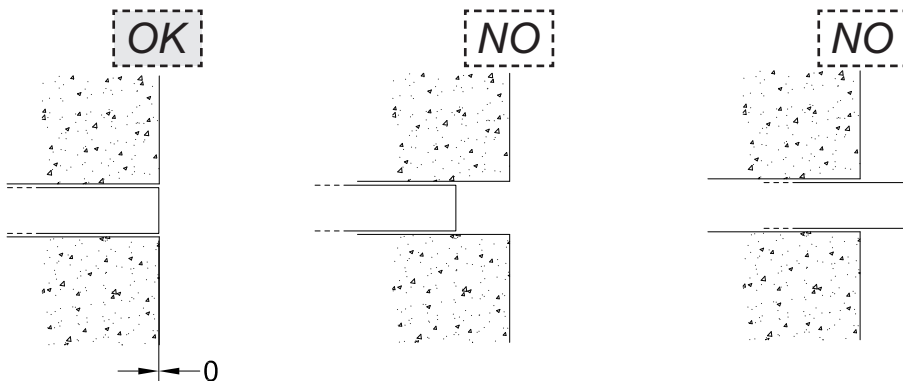

Fig. 19

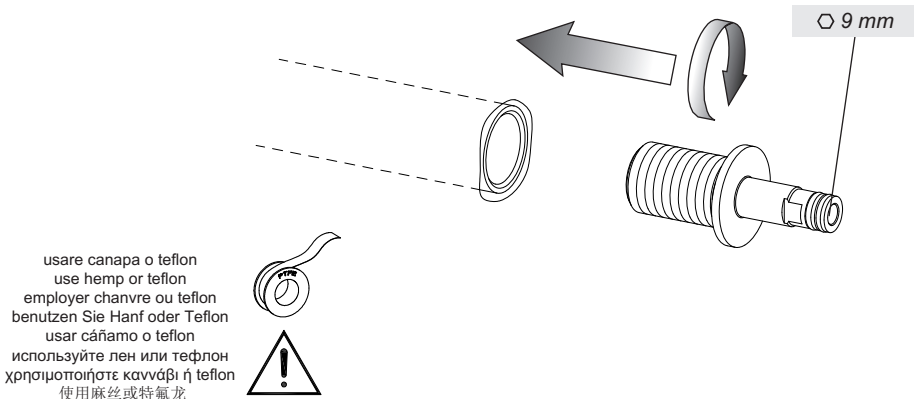

Fig. 20

