

PROGRAMMA MISCELAZIONE BAGNO
BATH MIXING PROGRAM
PROGRAMME DU MITIGEUR POUR LA SALLE DE BAIN
BAD-MISCHUNGSPROGRAMM
PROGRAMA MEZCLADORES BAÑO

VIA MANZONI

Art. 38657

Art. 38760

GESSI 

Gessi SpA - Parco Gessi

13037 Serravalle Sesia (Vercelli) - Italy

Phone +39 0163 454111 - Facsimile +39 0163 459273

www.gessi.com - gessi@gessi.it

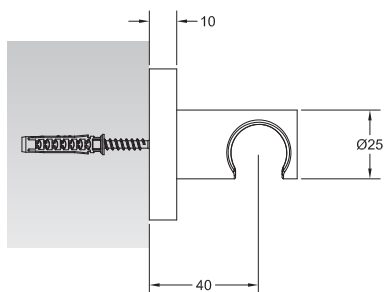
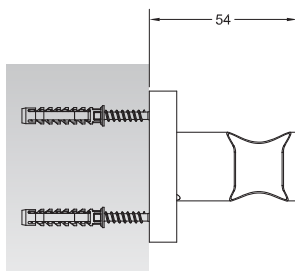
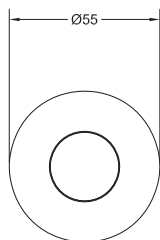

Art. 38657

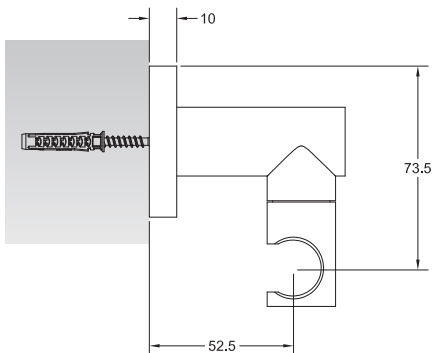
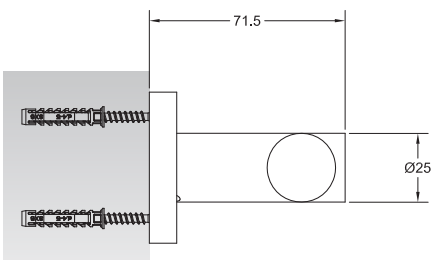
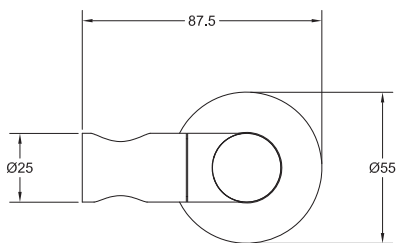

Art. 38760

Fig. 1

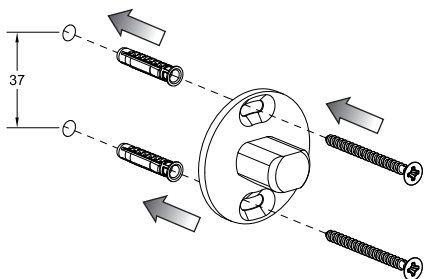

Fig. 2

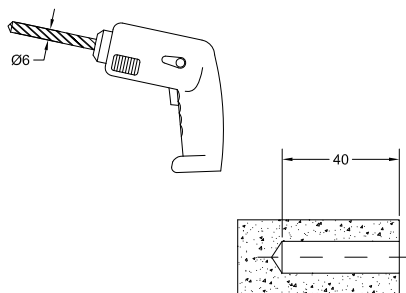

Fig. 3

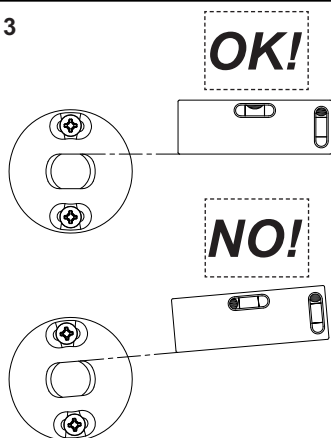

Fig. 4a

Art. 38657

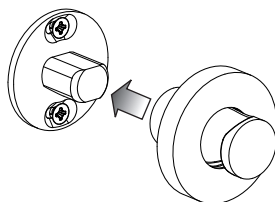

Fig. 4b

Art. 38760

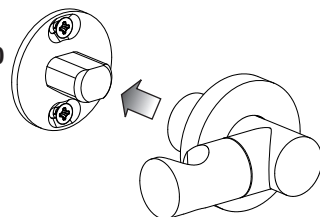

Fig. 5

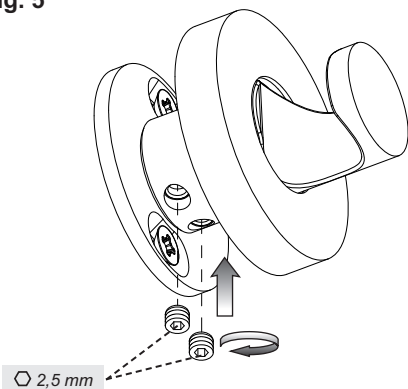

Fig. 6

