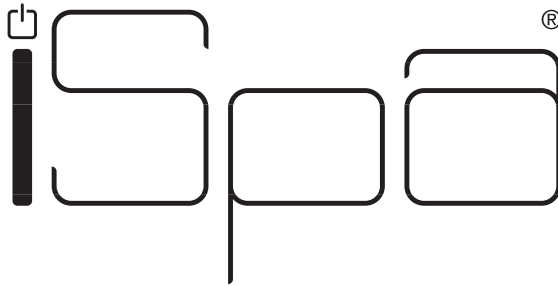

PROGRAMMA ACCESSORI
ACCESSORIES PROGRAM
PROGRAMME DU ACCESSOIRES
ZUBEHÖR PROGRAMM
PROGRAMA ACESORIOS
ЛИНИЯ АКЦЕССУАРОВ
ΠΡΟΓΡΑΜΜΑ ΕΞΑΡΤΗΜΑΤΩΝ
浴室产品配件

iSpa®

Art. 41793

GESSI 

Gessi SpA - Parco Gessi

13037 Serravalle Sesia (Vercelli) - Italy

Phone +39 0163 454111 - Facsimile +39 0163 459273

www.gessi.com - gessi@gessi.it

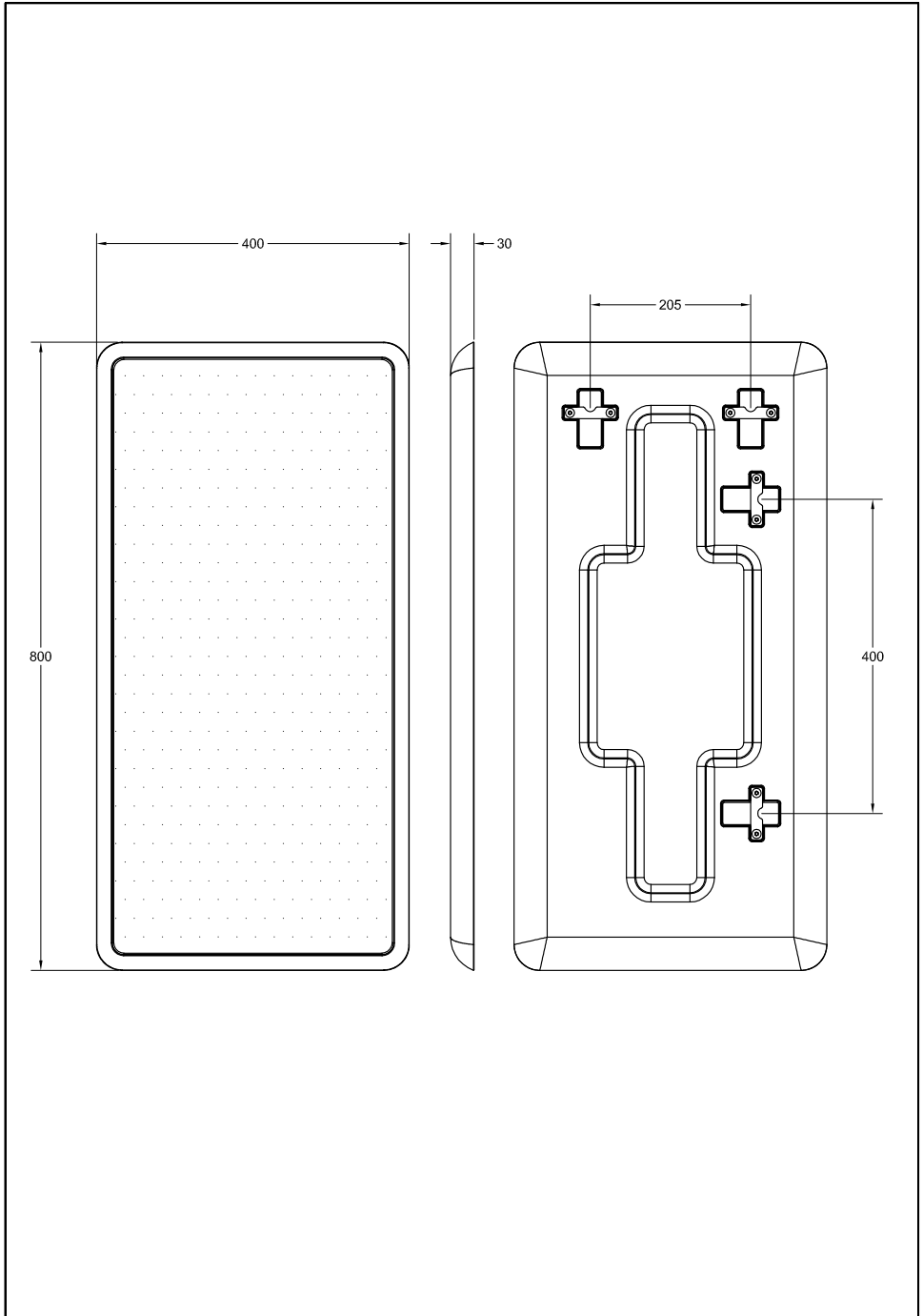

Fig. 1a

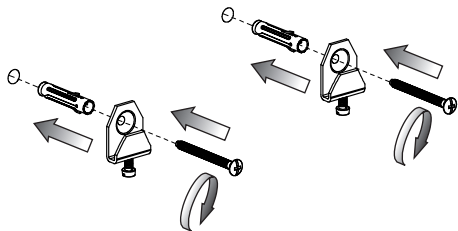
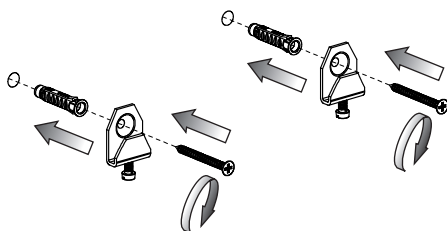
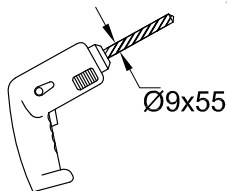

Fig. 1b



Set di fissaggio per muri pieni
 Fixing kit for solid wall
 Set de fixation pour murs pleins
 Befestigungsset für Vollwände
 Kit de anclaje para paredes llenas
 Крепежный комплект для полнотелых стен
 Σετ στερέωσης για υφιστάτους τοίχους
 所有墙面的全套固定装置



Set di fissaggio standard
 Standard fixing kit
 Set de fixation standard
 Standard Befestigungsset
 Kit de anclaje para paredes standard
 Стандартный крепежный комплект
 Στάνταρ σετ στερέωσης
 全套标准固定装置

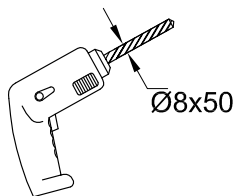

Fig. 2

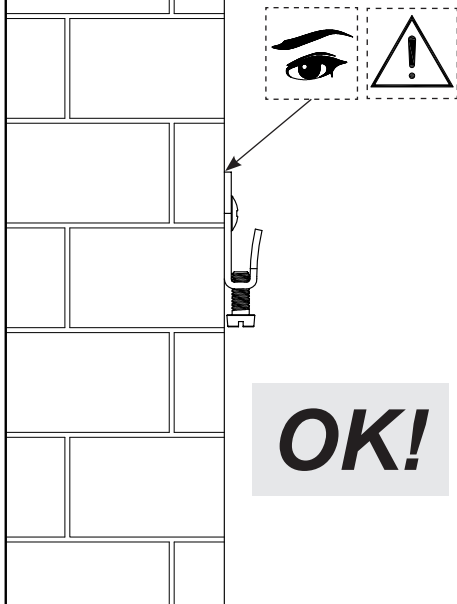

Fig. 3

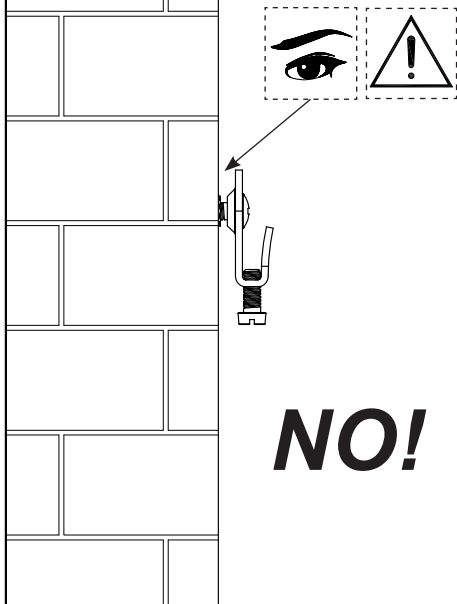

Fig. 4

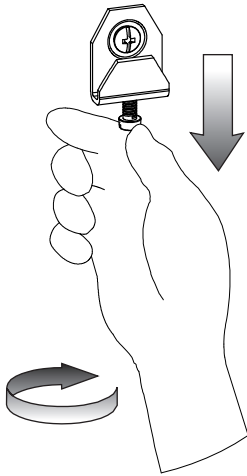

Fig. 5

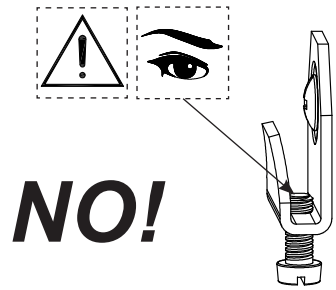
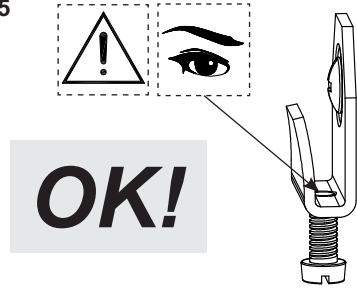

Fig. 6

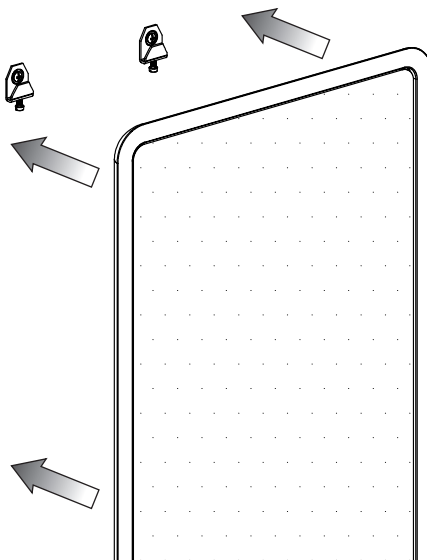

Fig. 7

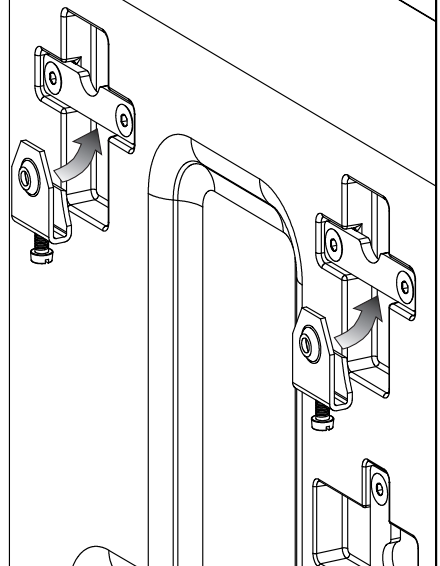
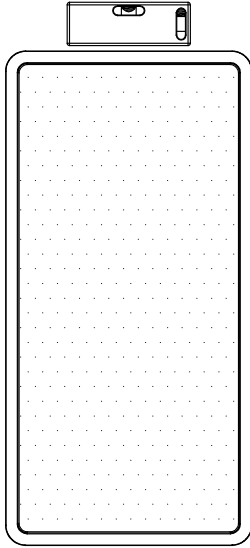
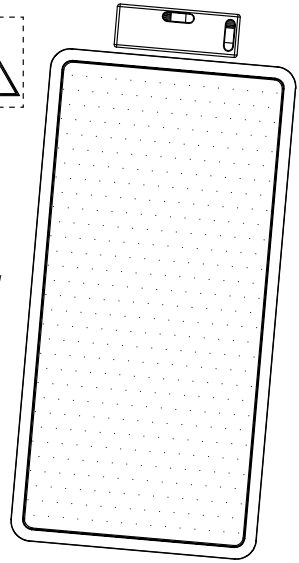

Fig. 8



OK!

Fig. 9



NO!

Fig. 10

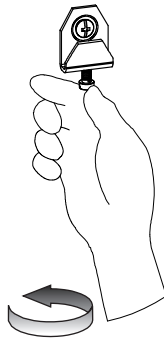
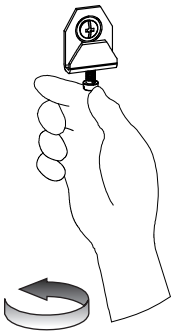

OK!

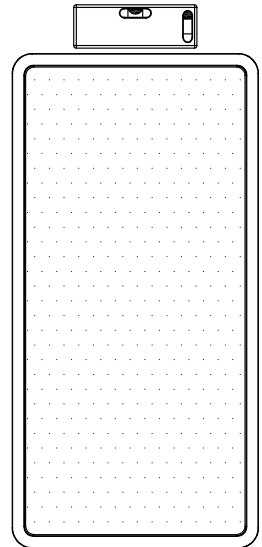
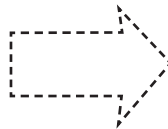

A series of horizontal dotted lines for writing notes.

