

PROGRAMMA MISCELAZIONE BAGNO  
BATH MIXING PROGRAM  
PROGRAMME DU MITIGEUR POUR LA SALLE DE BAIN  
BAD-MISCHUNGSPROGRAMM  
PROGRAMA MEZCLADORES BAÑO

# RETTANGOLO

Art. 20142

Art. 20143

Art. 20145

Art. 20146

Art. 20442

Art. 20443

Art. 20445

Art. 20446

**GI** 

**Gessi SpA** - Parco Gessi

13037 Serravalle Sesia (Vercelli) - Italy

Phone +39 0163 454111 - Facsimile +39 0163 459273

[www.gessi.com](http://www.gessi.com) - [gessi@gessi.it](mailto:gessi@gessi.it)

INSTALLAZIONE - INSTALLATION - INSTALACIÓN - INSTALLATION - INSTALACIÓN

dimensioni in mm - measures in mm - dimensions en mm - Maß in mm - medidas en mm

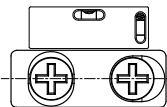
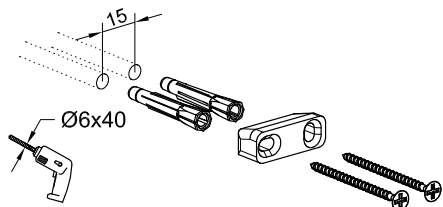

OK

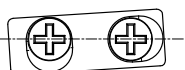

NO!

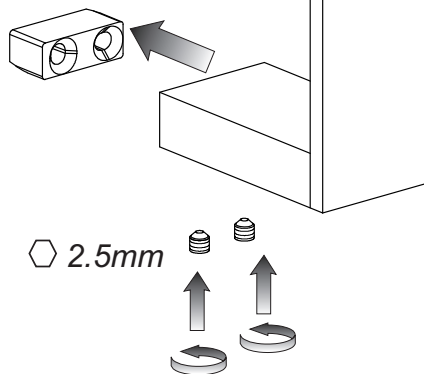
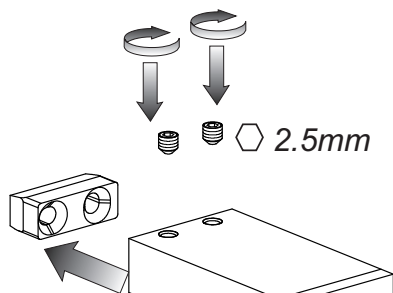
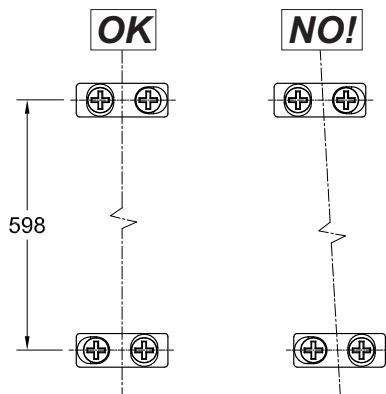

INSTALLAZIONE - INSTALLATION - INSTALLACIÓN - INSTALLATION - INSTALACIÓN

dimensioni in mm - mesures in mm - dimensions en mm - Maß in mm - medidas en mm

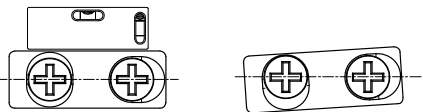
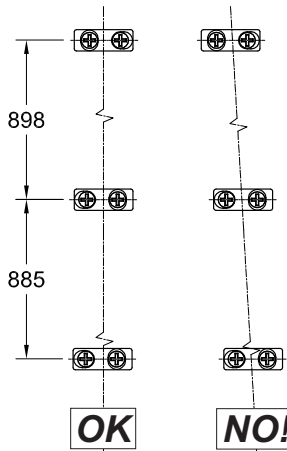
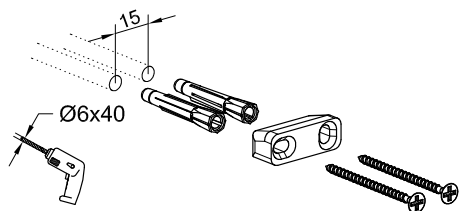

**OK**

**NO!**

**OK**

**NO!**

