

BUILT-IN PART

INC 063

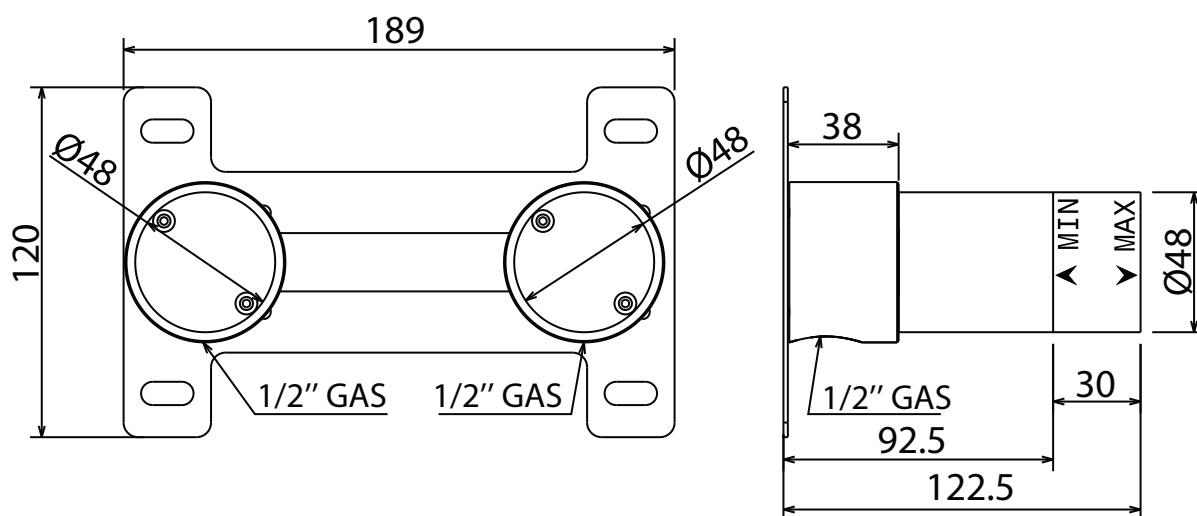

Built-in part
Parte incasso