

# BUILT-IN PART

INC 065

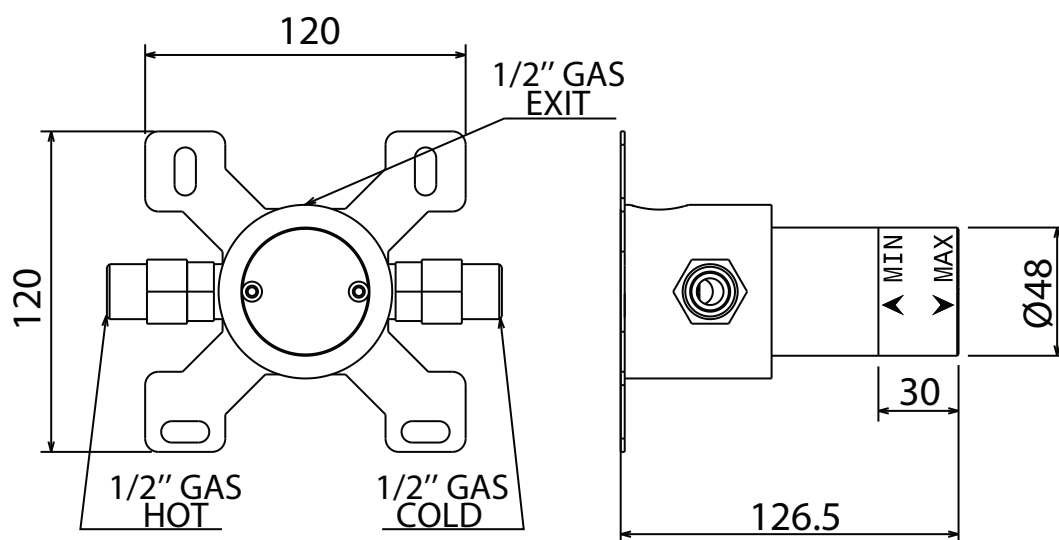

Built-in part  
Parte incasso