

BUILT-IN PART

INC 068

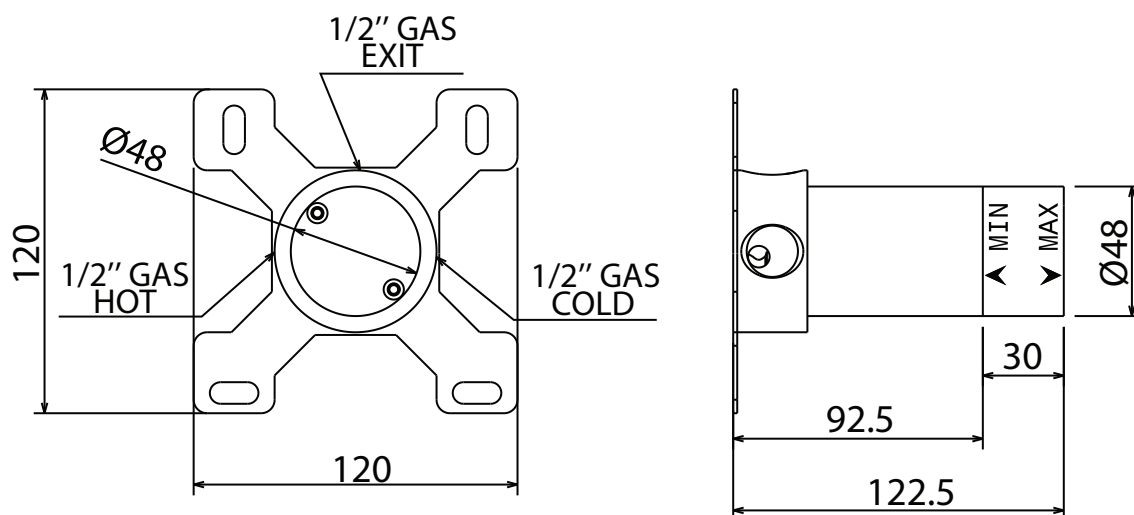

Built-in part
Parte incasso